

# ASSEMBLY INSTRUCTION CHEST 2 OVER 3

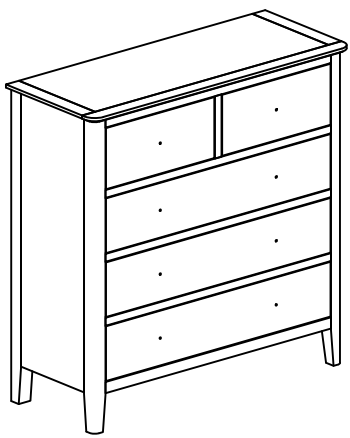

No	Name of Component	Q.ty
A		1

## STEP 1

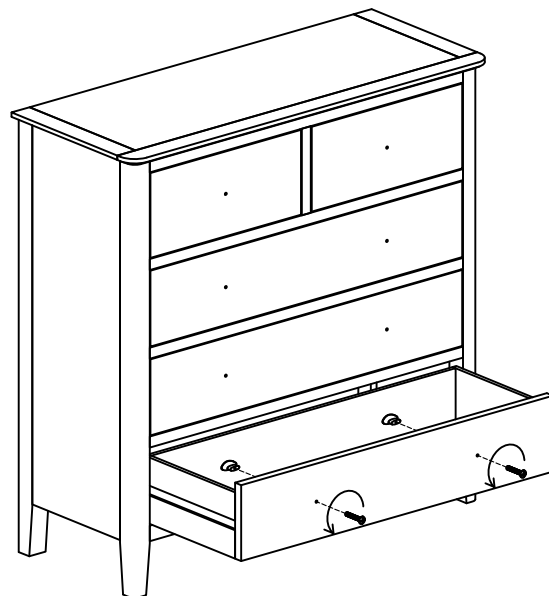

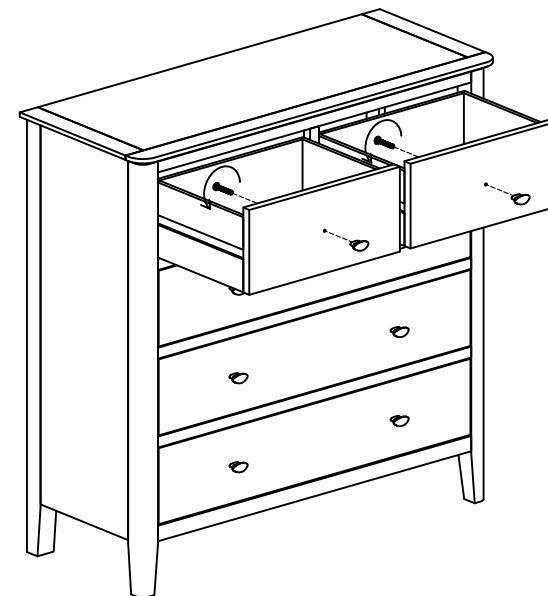
## STEP 2

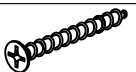

No	Name of Hardware	Q.ty
1	Bracket 	2
2	Tie 	1
3	Screw M4 x 20 	2
4	Screw M4 x 35 	2

## STEP 3

