



# PADDINGTON

Swivel Recliner & Footstool

## ASSEMBLY INSTRUCTIONS



# STOP! IMPORTANT:

Please read this manual carefully before beginning assembly of this product.  
Keep this manual for future reference.

Use the product only in a way specified under instruction manual.  
Incorrect usage voids product warranty.

## FIRE RETARDANCY

GFA's leathers/bonded leathers/PUs/fabrics meet the requirements of BS5852 Part 1 Source 0 (Cigarette) Ignition Source 1 (Match) as laid out in the UK Furniture and Furnishings (Fire)(Safety) Regulations 1988 with amendments in 1989, 1993 and 2010.



## IMPORTANT

This product is designed to seat people up to a maximum of 115kgs (18 stone)

Check and re-tighten parts/nuts & bolts every three months

**Please retain these instructions for future reference and in case of any queries,  
please quote the following batch number to your retailer.  
(The batch number is also located on the underside of the seat pad or  
footstool pad)**



# SAFETY INFORMATION

---

## **WARNING:**

This item contains small parts which can be swallowed by children and pets. Keep children and pets away during assembly.

To avoid danger of suffocation, always keep plastic bags away from children and pets.

We recommend that you assemble this unit on a carpeted floor to avoid scratches.

We do not recommend the use of power tools for assembly as this could damage the unit. Only use manual tools.

# CARE INSTRUCTIONS

---

Wipe regularly with clean water and a damp, clean, soft white cloth

General cleaning can be done as needed with a mild detergent and water solution. Always rinse with clean water and dry

For heavy soiling, dampen a soft white cloth or soft bristle brush. Use care as scrubbing can damage the surface

More difficult stains can be treated, but this should be occasional, not daily, cleaning

**ANY** cleaning solution used must be removed with clean water and a clean white cloth

Cleaning residue left on the material can cause it to dry out and crack, or affect the colour

# WARRANTY

---

Thank you for purchasing a product from Global Furniture Alliance. These products have been made to demanding, high-quality standards and are guaranteed for domestic use against manufacturing faults for a period of 12 months from the date of purchase.

This warranty does not affect your statutory rights.

We reserve the right to repair or replace the defective product, at its discretion.

This product is guaranteed for 12 months if used for normal purposes. Any warranty is invalid if the product has been overloaded or subject to neglect, improper use or an attempted repair by other than an authorized agent. Heavy-duty or daily professional/commercial usage are not guaranteed.

Due to continuous product improvement, we reserve the right to change the product specifications without prior notice.

## HELP WITH ASSEMBLY

For any assistance with assembly, please contact Global Furniture Alliance on **01291 645080 - Option 2** or email **service@gfa.uk.com**

Alternatively you can go to the following websites:-

- [www.youtube.com](https://www.youtube.com) (YouTube Channel - Global Furniture Alliance)
- [www.gfa.uk.com](https://www.gfa.uk.com) (Product Ranges - Assembly instruction Videos)

**For any missing/damaged parts, please contact your retailer**

# PRE ASSEMBLY INSTRUCTIONS

Identify all the parts and hardware.

Do not discard of the packaging until you have checked that you have all of the parts and hardware required.

Hardware package may have spare parts.

## What you need



**30**  
MINUTES











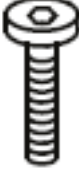

**2**  
PEOPLE

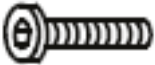

**0**  
EXTRA TOOLS

# HARDWARE DESCRIPTION

<p>A</p>  <p>8 pcs M6 x 20</p>	<p>B</p>  <p>8 pcs</p>	<p>C</p>  <p>1 pcs M8 x 60</p>
<p>D</p>  <p>1 pcs</p>	<p>E</p>  <p>2 pcs</p>	<p>F</p>  <p>2 pcs</p>
<p>G</p>  <p>2 pcs M8 x 40</p>	<p>H</p>  <p>4 pcs M6 x 20</p>	<p>I</p>  <p>1 pcs</p>
<p>J</p>  <p>1 pcs 5mm</p>	<p>K</p>  <p>1 pcs</p>	<p>L</p>

# CHAIR ASSEMBLY

## STEP 1

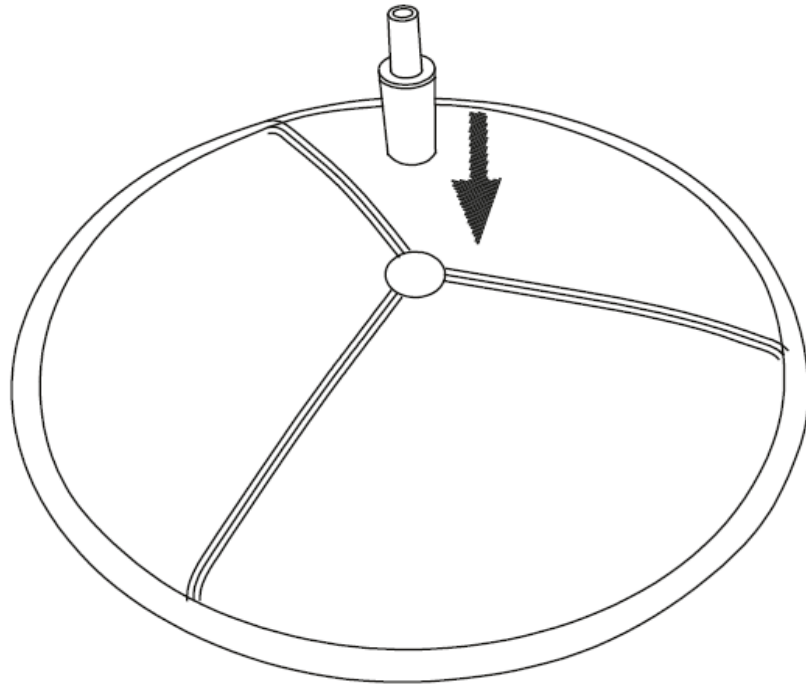

## STEP 2

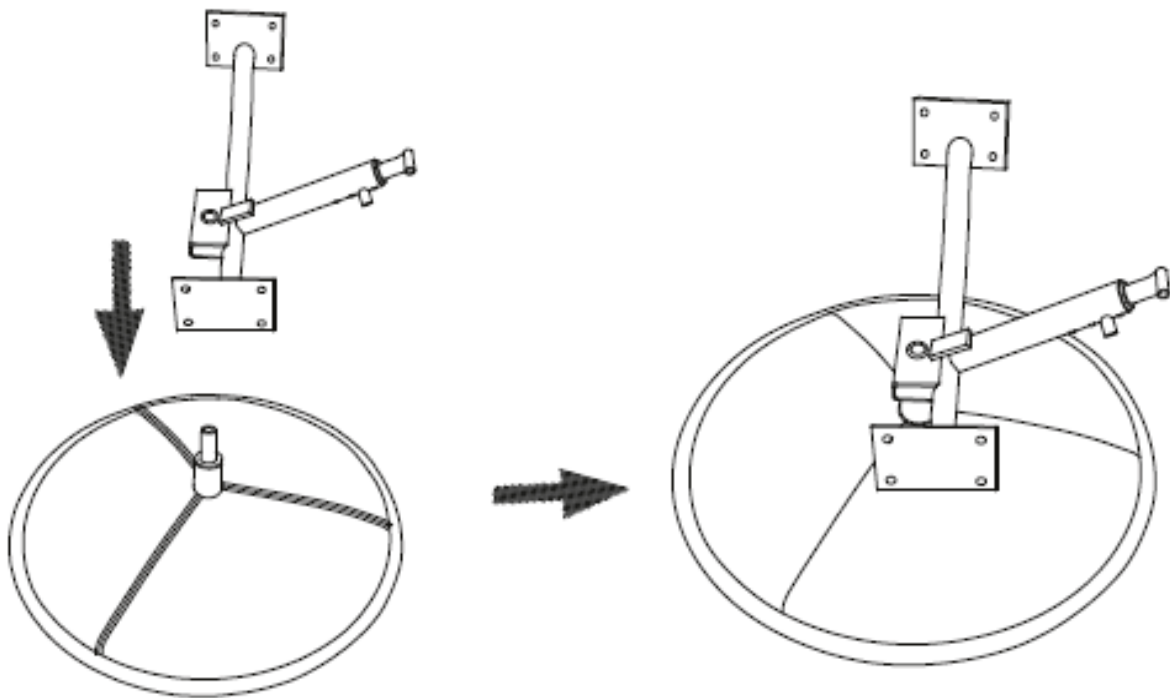

# CHAIR ASSEMBLY

## STEP 3

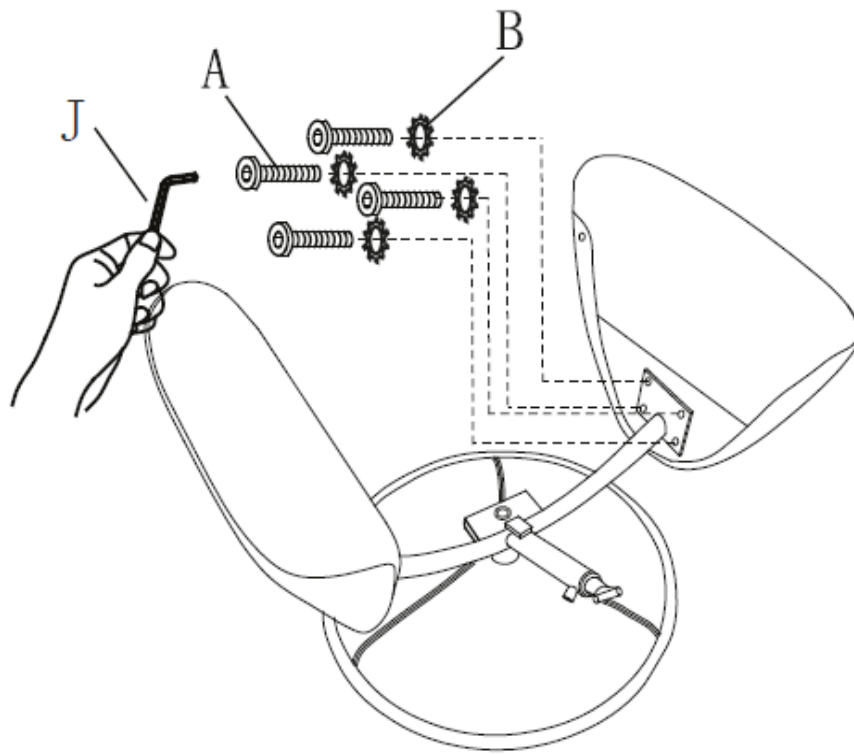

## STEP 4

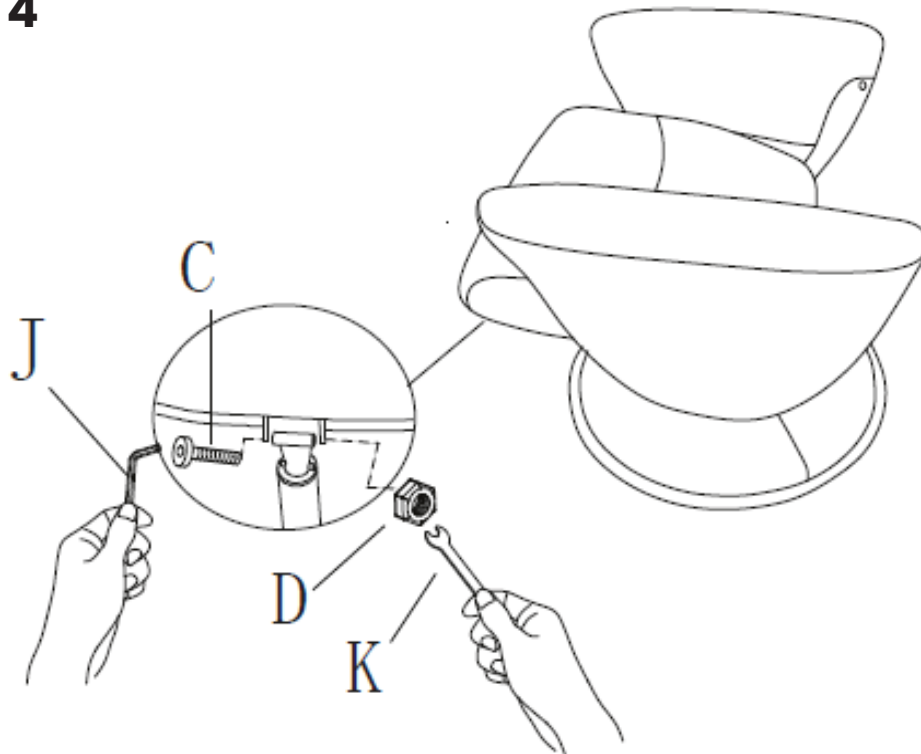



# CHAIR ASSEMBLY

## STEP 5

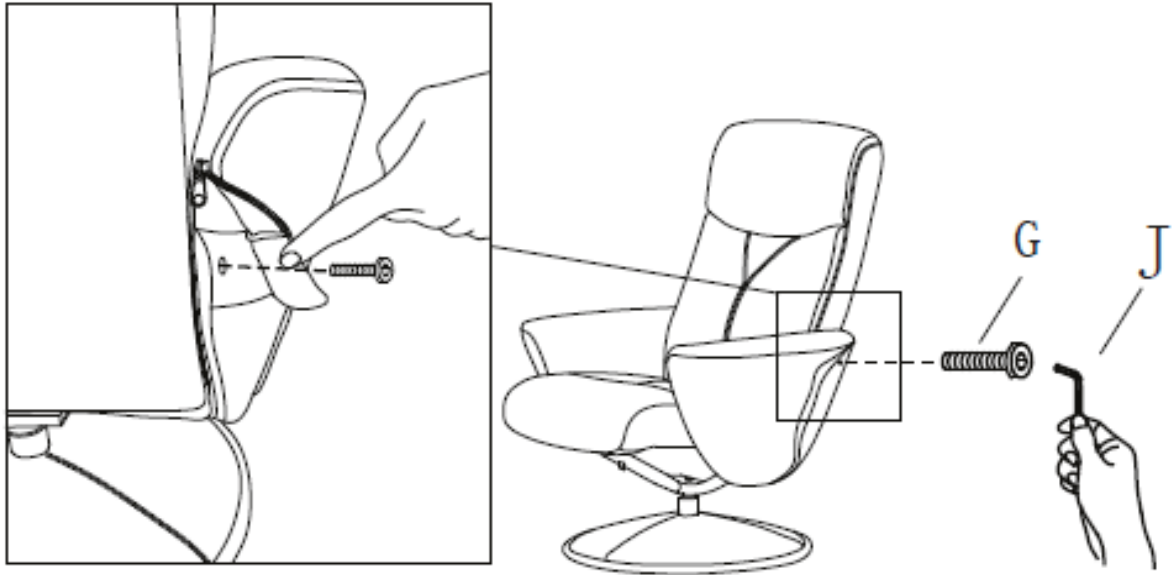

## STEP 6

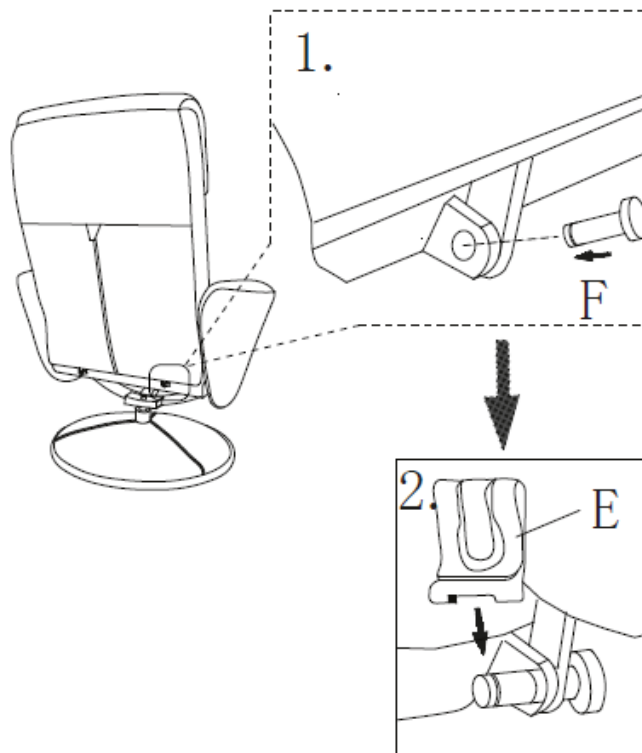

# CHAIR ASSEMBLY

## STEP 7

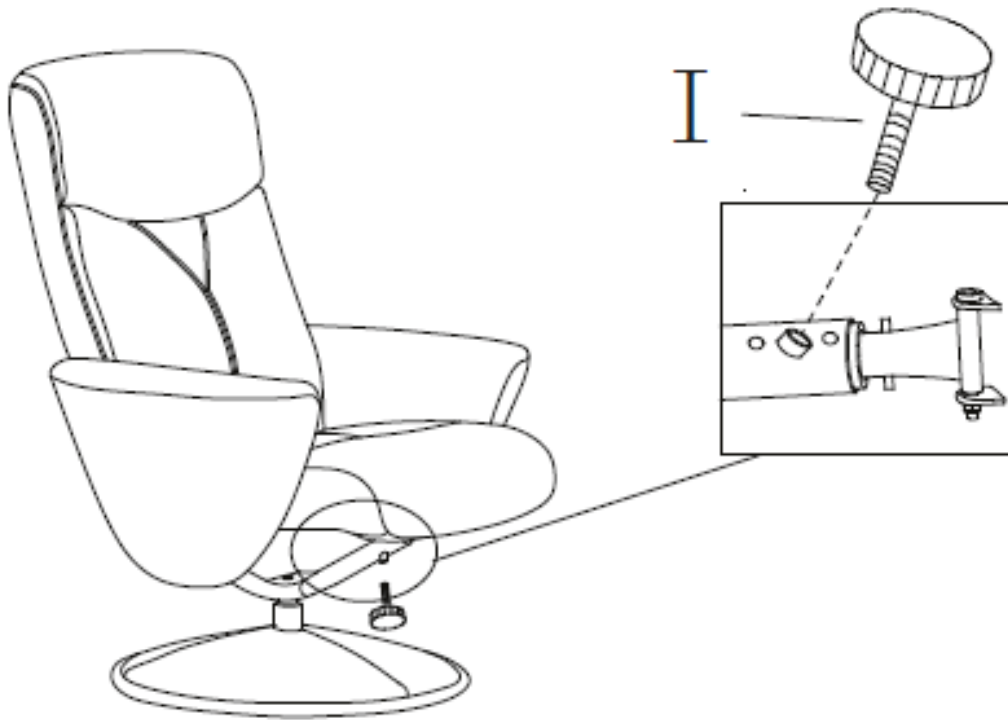

# FOOTSTOOL ASSEMBLY

## STEP 8

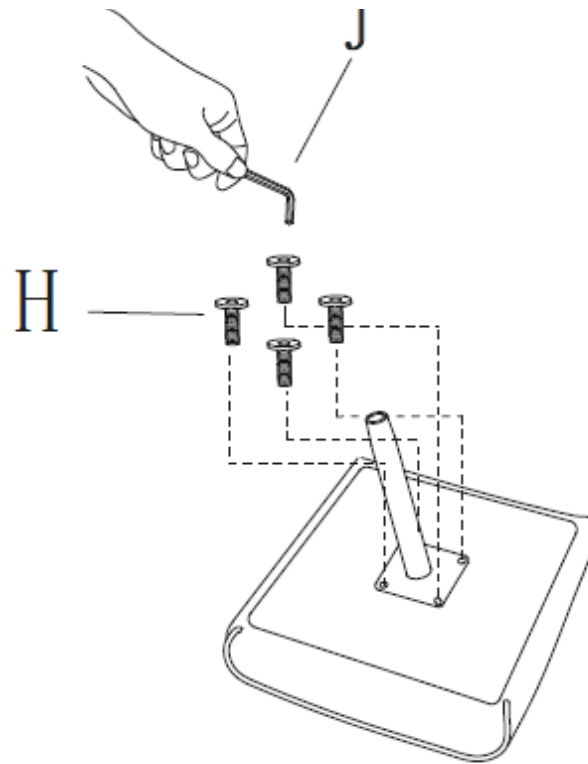

## STEP 9

